

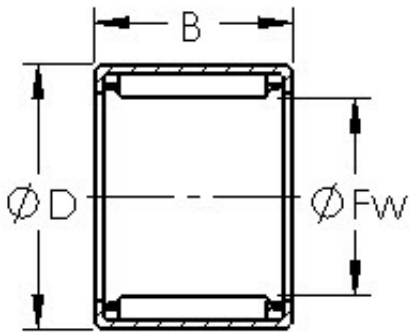

## BEARING de Mexico?S.A.



### AST HK1210 Needle bearings

Bearing No. HK1210

Size	12x18x10 mm
Bore Diameter	12 mm
Outer Diameter	18 mm
Width	10 mm
Bearing Type	Cage Retained Rollers
Outer Dia (D)	18.0000
Width (B)	10.0000
Dynamic Load Rating (Cr)	4,950
Static Load Rating (Cor)	6,200
Max Speed (Grease) (X1000 RPM)	20,000
Shaft (Fw)	12.000
Weight (g)	5.00
Material - Drawn cup: Hardened carbon steel alloy, Rollers	52100 Chrome steel or equivalent

HK1210 Bearing 2D drawings and 3D CAD models