

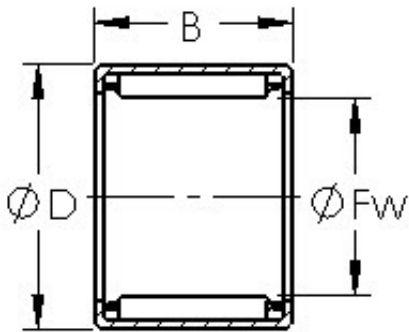

## BEARING de Mexico?S.A.



### AST HK1412 Needle bearings

Bearing No. HK1412

Size	14x20x12 mm
Bore Diameter	14 mm
Outer Diameter	20 mm
Width	12 mm
Bearing Type	Cage Retained Rollers
Outer Dia (D)	20.0000
Width (B)	12.0000
Dynamic Load Rating (Cr)	7,100
Static Load Rating (Cor)	8,500
Max Speed (Grease) (X1000 RPM)	16,000
Shaft (Fw)	14.000
Weight (g)	11.00
Material - Drawn cup: Hardened carbon steel alloy, Rollers	52100 Chrome steel or equivalent

HK1412 Bearing 2D drawings and 3D CAD models